

ROTATING OVEN / 1 DOOR

ROMA

RIF. COD. **FRIB** MF3RG/C 120



M.A.M. s.r.l.
Via C. Angiolieri, 28-34
41123 Modena (Italy)
Tel. +39 059 330219
mam@mamforni.it
P. IVA 02170610360



www.mamforni.it

TECHNICAL CHARACTERISTICS

MODEL	UM	Ø 95
Height of the cooktop	cm	120
Door width	cm	54/68
Power consumption	Kw Volt	0,36 220
Total weight (standard finish)	Kg	1300
Pizza capacity	n.	5 - 6
Under-floor burner		O

Minimum flue dimensions: Ø 20 cm.



DIMENSIONS	UM	Ø 95
A - DEPTH	cm	163
B - WIDTH	cm	152
C - HEIGHT	cm	190
D	cm	120
E	cm	105
F	cm	94
G	cm	105
External band projection over the feet of the oven	cm	17

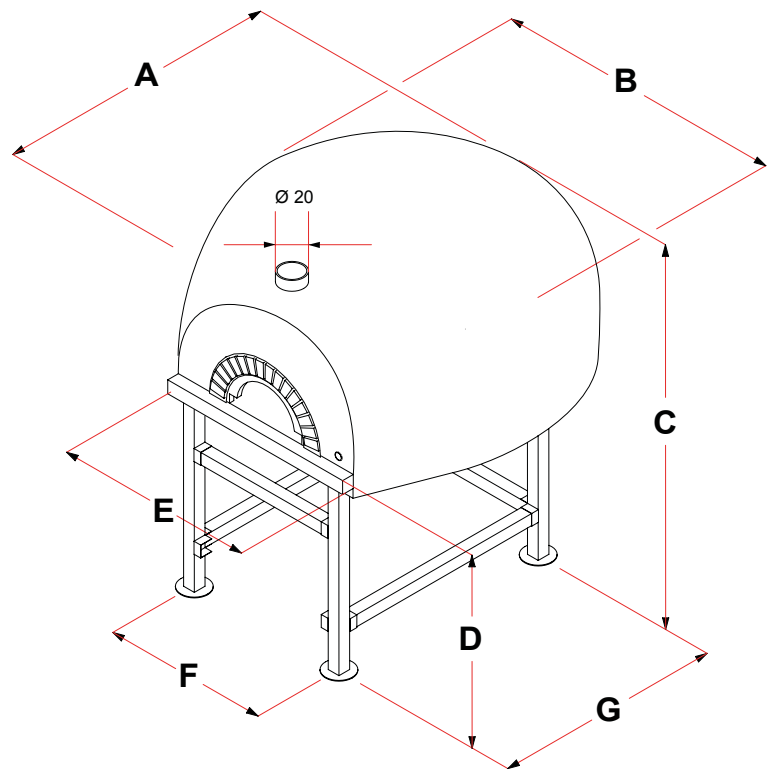

GAS THERMAL DATA	UM	Ø 95
Thermal power	Kw	34
LPG consumption	Kg/h	2,681
Natural Gas consumption	m³/h	3,598
Smoke temperature	°C	200
Flue gas draught	Pa	12
Gas Connection	in	1/2
Type of Construction		A1-B11BS
Electricity consumption	W	370

