

# STATIC OVEN / 1 DOOR MILANO

**TRADITIONAL**  
RIF. COD. **T MF3G/C 120**



**M.A.M. s.r.l.**  
Via C. Angiolieri, 28-34  
41123 Modena (Italy)  
Tel. +39 059 330219  
mam@mamforni.it  
P. IVA 02170610360



[www.mamforni.it](http://www.mamforni.it)

## TECHNICAL CHARACTERISTICS

MODEL	UM	Ø 120
Height of the cooktop	cm	120
Door width	cm	54/68/82
Total weight (basic finish)	Kg	1700
Pizza capacity	n.	7 - 8

Minimum flue dimensions: Ø 20 cm

DIMENSIONS	UM	Ø 120
A - DEPTH	cm	175
B - WIDTH	cm	165
C - HEIGHT	cm	200
D	cm	120
E	cm	114
F	cm	100
G	cm	116
Headband foot overhang	cm	20

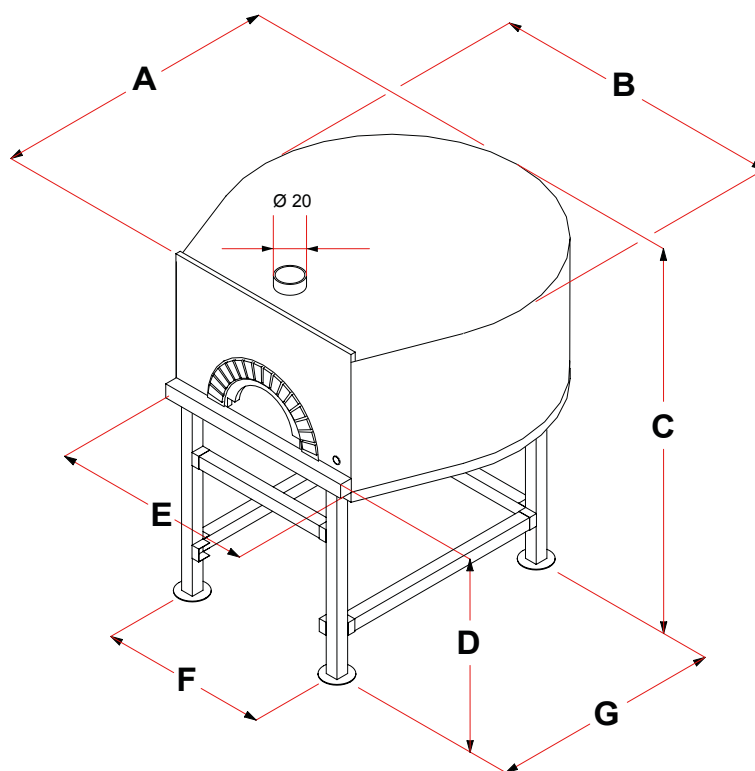
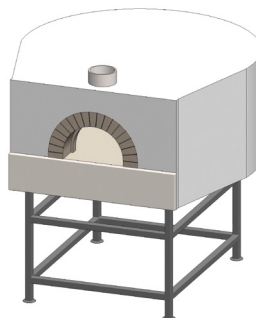

GAS THERMAL DATA	UM	Ø 120
Thermal power	Kw	34
LPG consumption	Kg/h	2,681
Natural Gas consumption	m³/h	3,598
Smoke temperature	°C	200
Flue gas draught	Pa	12
Gas Connection	in	1/2
Type of Construction		A1-B11BS
Electricity consumption	W	100

WOOD DATA	
Minimum distance from the combustible material	Contact
CO emission produced during combustion	0,48 %
Combustion fume temperature	305° C
Thermic outlet used (heating)	11,5 Kw
Energy efficiency	66,7 %
Fuel typer	Wood logs
CO** (mg/Nm³)	5848
Powders** (mg/Nm³)	248

MADE IN ITALY 05

Prefabricated wood-fired oven  
1935/2004 - 2001/95/CE

\*\* values corrected to 10% of O<sub>2</sub>

