

ROTATING OVEN / 1 DOOR MILANO

RIF. COD. **FRIB** FLR 160



M.A.M. s.r.l.
Via C. Angiolieri, 28-34
41123 Modena (Italy)
Tel. +39 059 330219
mam@mamforni.it
P. IVA 02170610360



www.mamforni.it

TECHNICAL CHARACTERISTICS

MODEL	UM	Ø 125
Height of the cooktop	cm	120
Door width	cm	54/68/82
Power consumption	Kw Volt	0,36 220
Total weight (standard finish)	Kg	1600
Pizza capacity	n.	8 - 9
Under-floor burner		O

Minimum flue dimensions: Ø 20 cm.

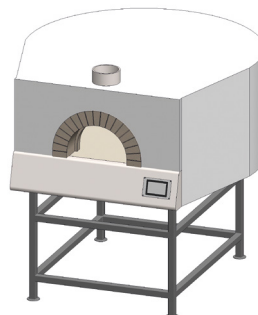

DIMENSIONS	UM	Ø 125
A - DEPTH	cm	200
B - WIDTH	cm	195
C - HEIGHT	cm	200
D	cm	120
E	cm	138
F	cm	116
G	cm	149
External band projection over the feet of the oven	cm	10

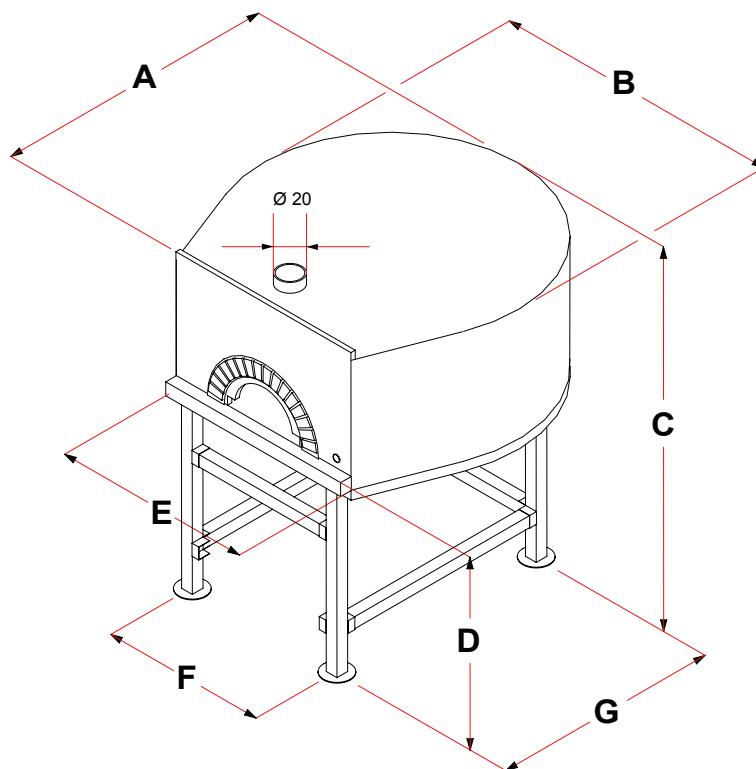

WOOD DATA

Minimum distance from the combustible material	Contact
CO emission produced during combustion	0,48 %
Combustion fume temperature	305° C
Thermic outlet used (heating)	11,5 Kw
Energy efficiency	66,7 %
Fuel typer	Wood logs
CO** (mg/Nm ³)	5848
Powders** (mg/Nm ³)	248

MADE IN ITALY **CE** 05

Prefabricated wood-fired oven
1935/2004 - 2001/95/CE

** values corrected to 10% of O₂

