

FORNO STATICO / 1 BOCCA MILANO

EASY RIF. COD. E



M.A.M. s.r.l.
Via C. Angiolieri, 28-34
41123 Modena (Italy)
Tel. +39 059 330219
mam@mamforni.it
P. IVA 02170610360



www.mamforni.it

CARATTERISTICHE TECNICHE

MODELLO	UM	Ø 80
Altezza piano di cottura	cm	120
Larghezza bocca	cm	46
Peso totale (finitura standard)	Kg	600
Capienza pizze	n.	3 - 4

Dimensioni minime canna fumaria: Ø 20 cm.

DIMENSIONI	UM	75 x 80
A - PROFONDITÀ	cm	117
B - LARGHEZZA	cm	104
C - ALTEZZA	cm	190
D	cm	120
E	cm	92
F	cm	70
G	cm	88
Sporgenza piedi fascia	cm	12

DATI TERMICI GAS	UM	Ø 80
Potenza Termica	Kw	11
Consumo GPL	Kg/h	0,867
Consumo Metano	m³/h	1,164
Temperatura Fumi	°C	200
Tiraggio	Pa	12
Allacciamento Gas	in	1/2
Tipo di Costruzione		A1-B1I1BS
Consumo corrente Elettrica	Kw	100

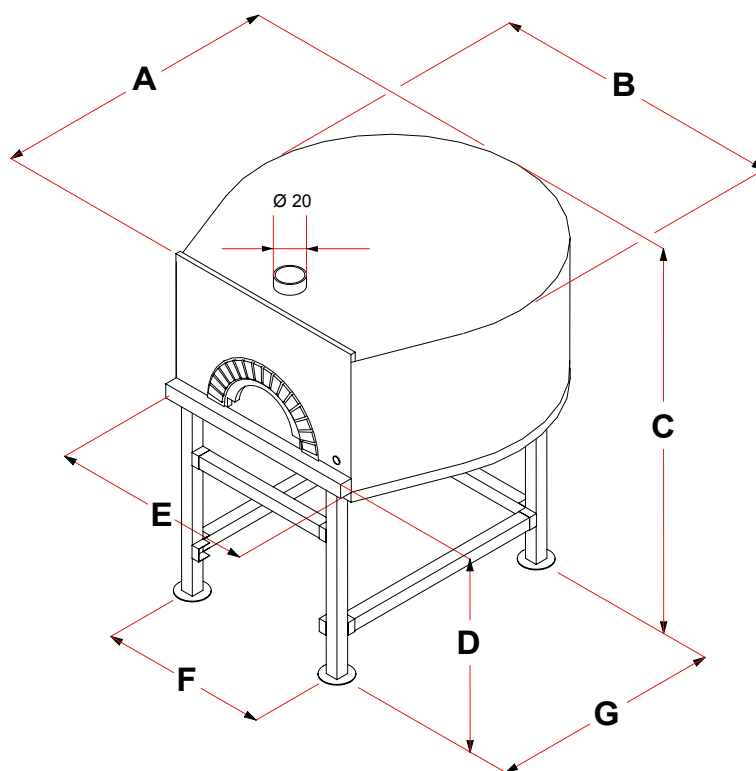
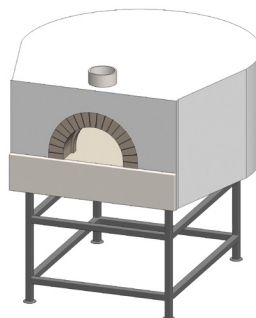

CE

IMQ Tested

