

FORNO STATICO / 1 BOCCA TORINO

RIF. COD. **TN**



M.A.M. s.r.l.
Via C. Angiolieri, 28-34
41123 Modena (Italy)
Tel. +39 059 330219
mam@mamforni.it
P. IVA 02170610360



www.mamforni.it

CARATTERISTICHE TECNICHE

MODELLO	UM	Ø 120
Altezza piano di cottura	cm	120
Larghezza bocca	cm	54/68
Peso totale (finitura standard)	Kg	1100
Capienza pizze	n.	7 - 8

Dimensioni minime canna fumaria: Ø 20 cm.

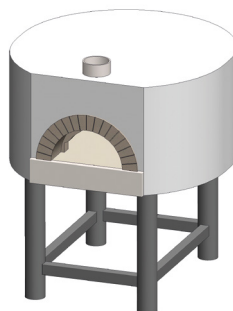

DIMENSIONI	UM	Ø 120
A - PROFONDITÀ	cm	180
B - LARGHEZZA	cm	160
C - ALTEZZA	cm	200
D	cm	120
F	cm	109
G	cm	105

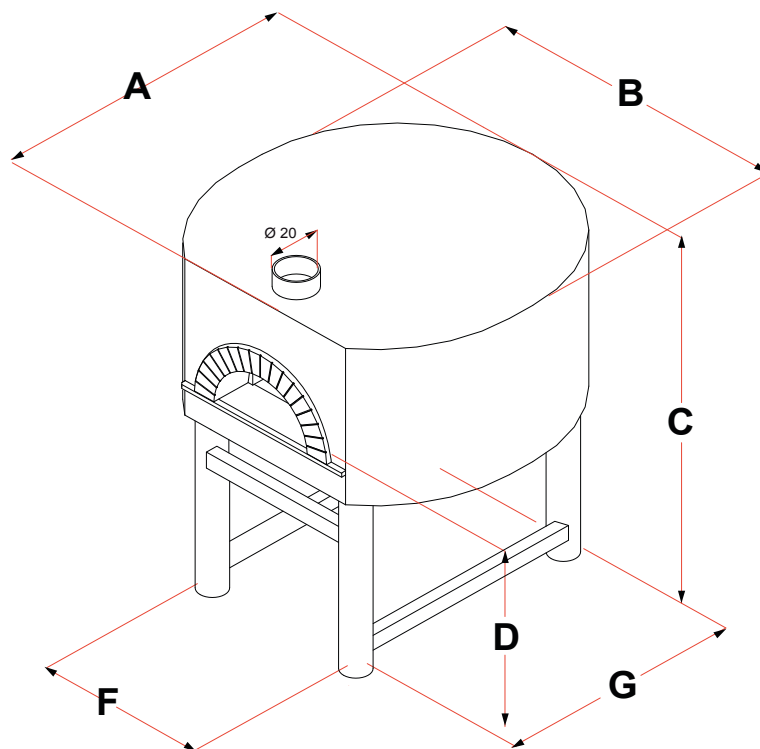

DATI LEGNA

Distanza Minima del materiale combustibile	Contatto
Emissione di CO prodotta in combustione	0,48 %
Temperatura del fumo di combustione	305° C
Uscita termica utile (riscaldamento)	11,5 Kw
Efficienza dell'energia	66,7 %
Tipo di combustibile	Legno in pezzi
CO (mg/Nm³)	5848
Polveri (mg/Nm³)	248

MADE IN ITALY **CE** 05

Forno a legna prefabbricato
1935/2004 - 2001/95/CE

